



TRINITY MEDICAL

PATIENT CENTRIC TECHNOLOGIES

Product Catalogue

2024

V1.1

www.trinitymed.ie

Since our establishment in 2017, Trinity Medical has progressed as a leading supplier of cutting-edge technology within the medical and scientific industries. Specialising in the areas of **Decontamination**, **Infection Prevention** and **Patient Monitoring**, we proudly take the lead in delivering innovative solutions that enhance clinical pathways and redefine patient outcomes. Whether partnering with those at the forefront of patient care, or collaborating with industry visionaries driving the next wave of scientific progress, Trinity Medical goes above and beyond the conventional supplier role. We strive to build enduring strategic partnerships with our customers, that help guide them towards resounding success in patient care.

This endeavour is underpinned by the four pivotal pillars of our Company.



Decontamination & Infection Control for Healthcare

Leading-edge solutions for Sterile Services, Endoscopy, Radiography and Ward-Level Infection Control."



Patient Monitoring & OR Solutions

Elevating care and empowering precision in the most critical areas of patient care.



Sterile Dynamics

Sterility Assurance & Environmental Decontamination Solutions for the Scientific Industries



Service & Validation

After-Sales Support, Product & Process Training, Technical Consultancy, Validation and Qualification Services

Contact Details

Ph: +353 (1) 460 4356 | Email: info@trinitymed.ie | www.trinitymed.ie

Trinity Medical is an ISO9001 certified company





PRODUCTS FOR
STERILE SERVICES

Partnering with PROHS - Product Range Overview

Cleaning & Disinfection - by PROHS

Trinity Medical offers a comprehensive range of Washer Disinfectors for both moderate and high through-put departments.



Steam Sterilisation - by PROHS

See our complete range of steam sterilisers / autoclaves. From benchtop models to free-standing high capacity machines.



Low Temperature Sterilisers vH2O2 - by PROHS

Our range of low temperature hydrogen peroxide plasma sterilisers offer patented technology with the first “Rapid Warmup and Dry System” .



ZAPARAY - RAY-ONE & RAY-TWO

Sustainable Disinfection with UVC-LED RAY-TWO

The RAY-TWO streamlines and enhances your daily disinfection routines with its user-friendly, automated, and secure design. UV-C disinfection complements existing procedures, offering viral and bacteriological reduction on surfaces, right after manual cleaning of visible contaminants. This automated approach not only ensures effectiveness but also lightens the burden on your workload, promoting biological safety

Features:

- For Hospital, Dental, Laboratory and medical practice.
- Fast cycle time, with traceability.
- No water, harsh chemicals required.
- Low power consumption.
- LED technology - No mercury UVC lamps!

- Viral Proven**
- Bactericidal Proven**
- Fungicidal Proven**
- Mycobacteria Proven**

Can be used with Zaparay's patented UVSEE Bags with colour changing ink.

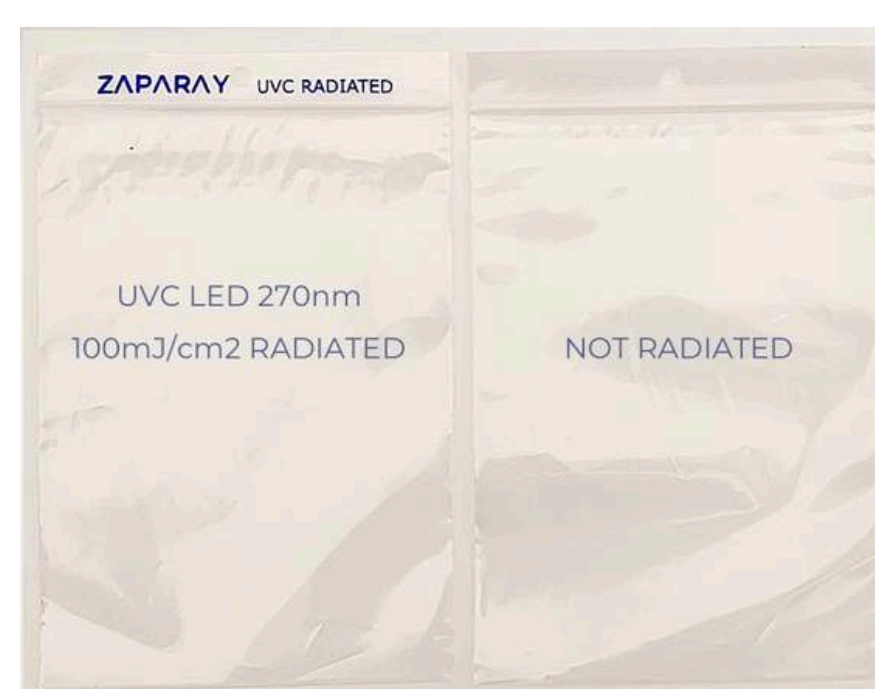

New - Sychem Surgical Range

Our new range of surgical instruments from Sychem Surgical.

Sychem's portfolio of instruments are manufactured in accordance to ISO 13485, and comply with the essential requirements of the Medical Devices Directive 93/42/EEC, offering full traceability throughout the entire manufacturing process. All surgical instruments manufactured in the UK, are supported by a 10 year warranty and are designed to meet the most demanding hygiene requirements.

**General Surgery | Oral & Maxillofacial | Neuro & Spine Surgery |
Cardiothoracic | Plastic Surgery | Otolaryngology (ENT) | Gynaecology &
Obstetrics | Urology | Proctology | Chiropody | Orthopaedic**



Scan for full brochure

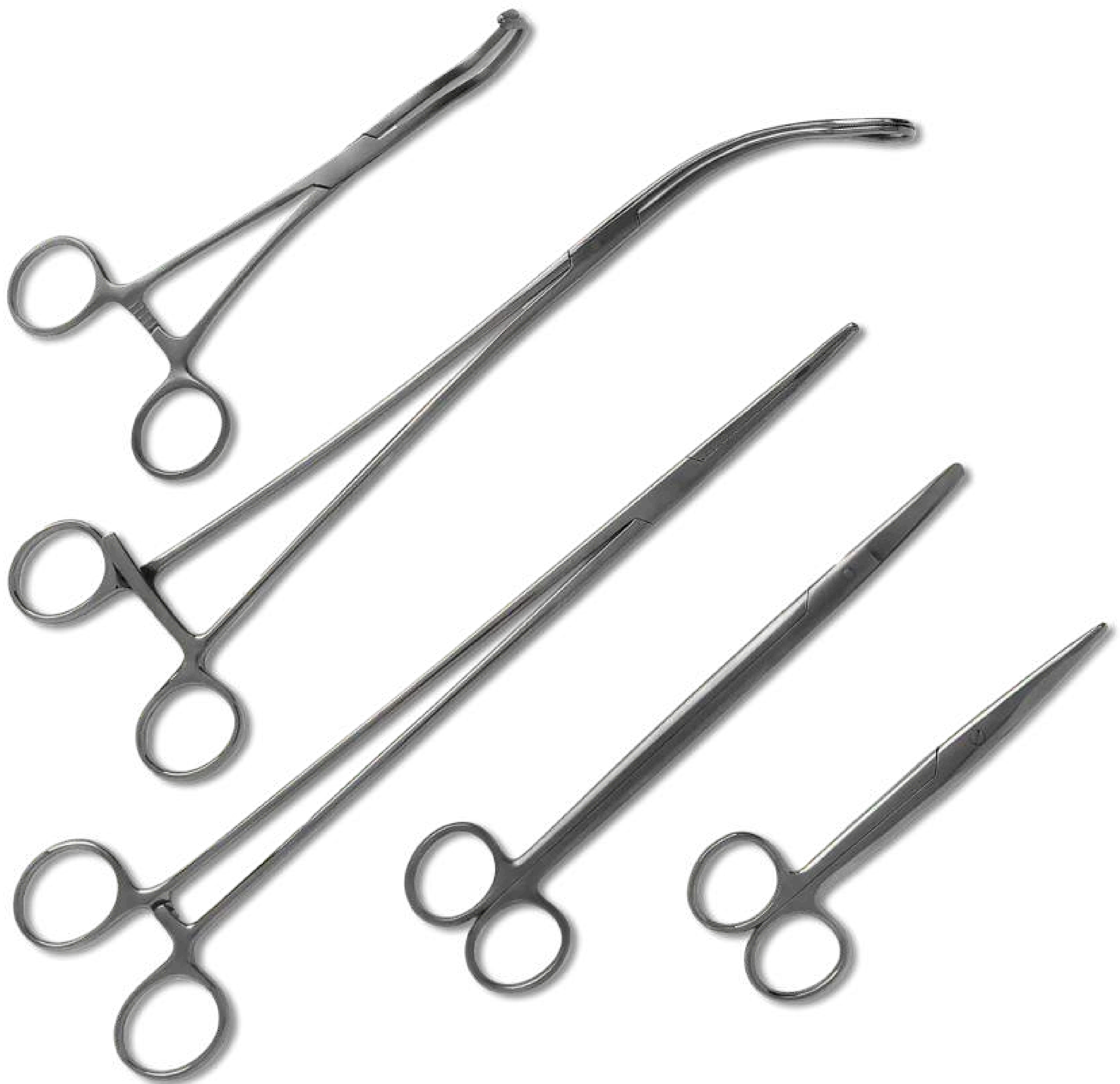

Non Linting Wipes



Code	Descript.	Pack	Notes
HNL400C	Non Linting Wipes 30x38cm	400sheets/bx	MOQ 4 boxes

Long Cuff Nitrile Glove



Code	Descript.	Pack	Notes
LCG-S, LCG-M, LCG-L, LGC-XL	40cm Long Cuff Glove	500/case	10/pk of 50, MOQ 1 case

Water Repellent Gown



Code	Descript.	Pack	Notes
810008	Water Repellent Gown	200/bx	MOQ applies

Disposable Face Shields



Code	Descript.	Pack	Notes
PS2000	Disposable Face Shield	200/bx	n/a



Reamer Cleaning Brush

Code	Descript.	Pack	Notes
50-ACETAB	Acetabular Reamer Cleaning Brush	3/pk	Reusable

General Cleaning Brush

Code	Descript.	Pack	Notes
28-72550-50	Cleaning Brush Nylon	50/pk	n/a

General Cleaning Brush

Code	Descript.	Pack	Notes
29-72550-50	Cleaning Brush Steel Bristle	50/pk	n/a

Precision Cleaning Brush

Code	Descript.	Pack	Notes
50-40800	Precision Cleaning Brush	3/pk	Autoclavable

Stainless Steel ARC™ Micro Brushes

Code	Descript.	Pack	Notes
35-03015	Micro Brush 1.5mm	6/pk	30cm Long
35-04515	Micro Brush 1.5mm	6/pk	45cm Long

General Cleaning Brush - Brass

Code	Descript.	Pack	Notes
29-70050	Cleaning Brush Brass	50/pk	n/a



Flat Cleaning Brush



Code	Descript.	Pack	Notes
50-40917	Flat Brush Blue	3/pk	Extra Rigid
50-40918	Flat Brush Green	3/pk	Rigid
50-40919	Flat Brush Yellow	3/pk	Flexible
50-40920	Flat Brush Red	3/pk	Extra Flexible
50-40921	Single-Use Flat Brush Orange	20/pk	Flexible
50-40922	Single-Use Flat Brush Light Blue	20/pk	Rigid

V- Brush



Code	Descript.	Pack	Notes
36-20005	Single Use V-Brush	50/pk	Reusable also available

Reusable Orthopedic Rasps Cleaning Brush



Code	Descript.	Pack	Notes
50-RASP	Cleaning Brush for Rasps	3/pk	n/a

Twisted Wire Cleaning Brush



Scan for full brochure

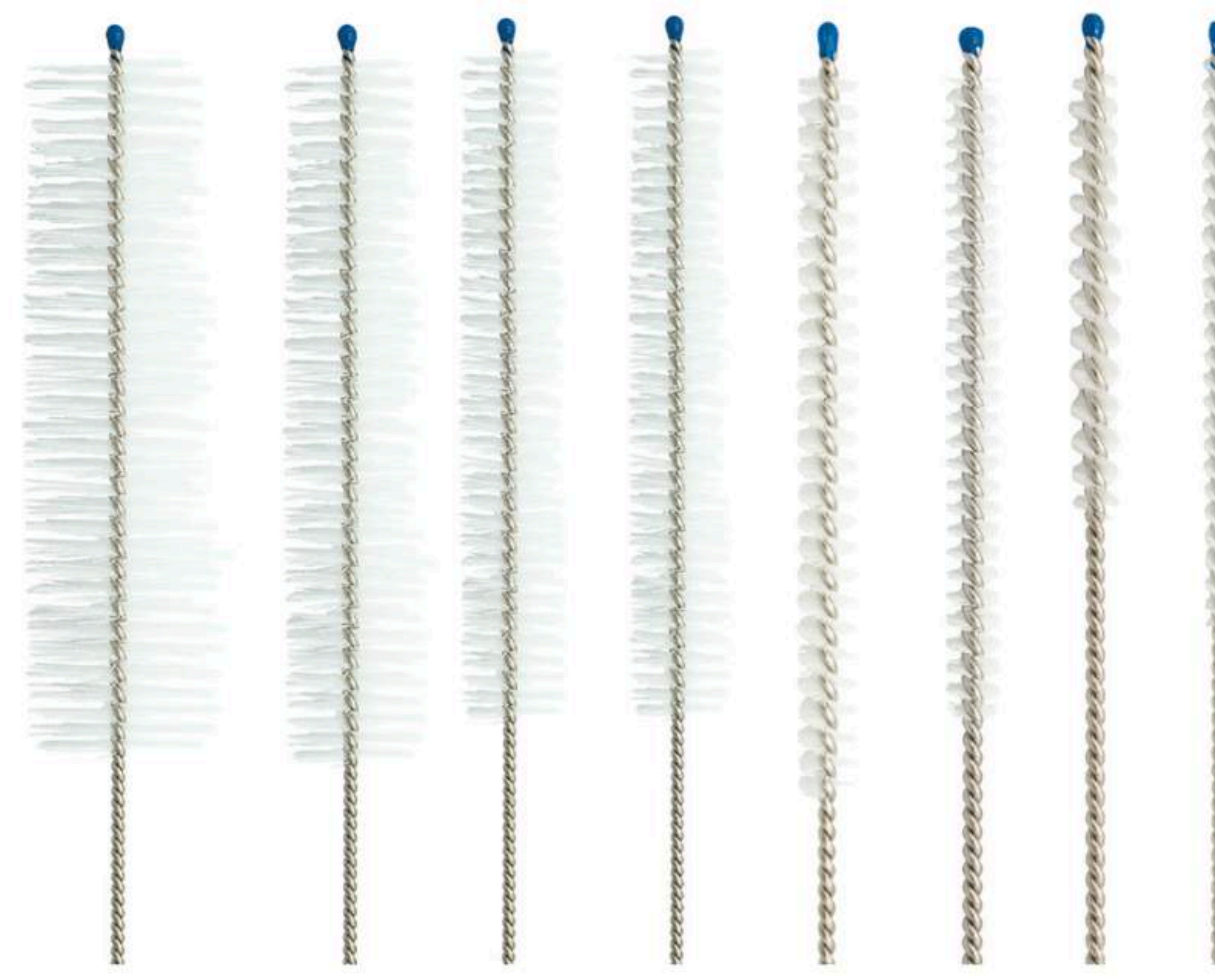

Code	Descript.	Pack	Notes
n/a	Various options available	3/pk & 50/pk	Contact Trinity Med for more info.

Arc Plastic Handle Brushes



Scan for full brochure

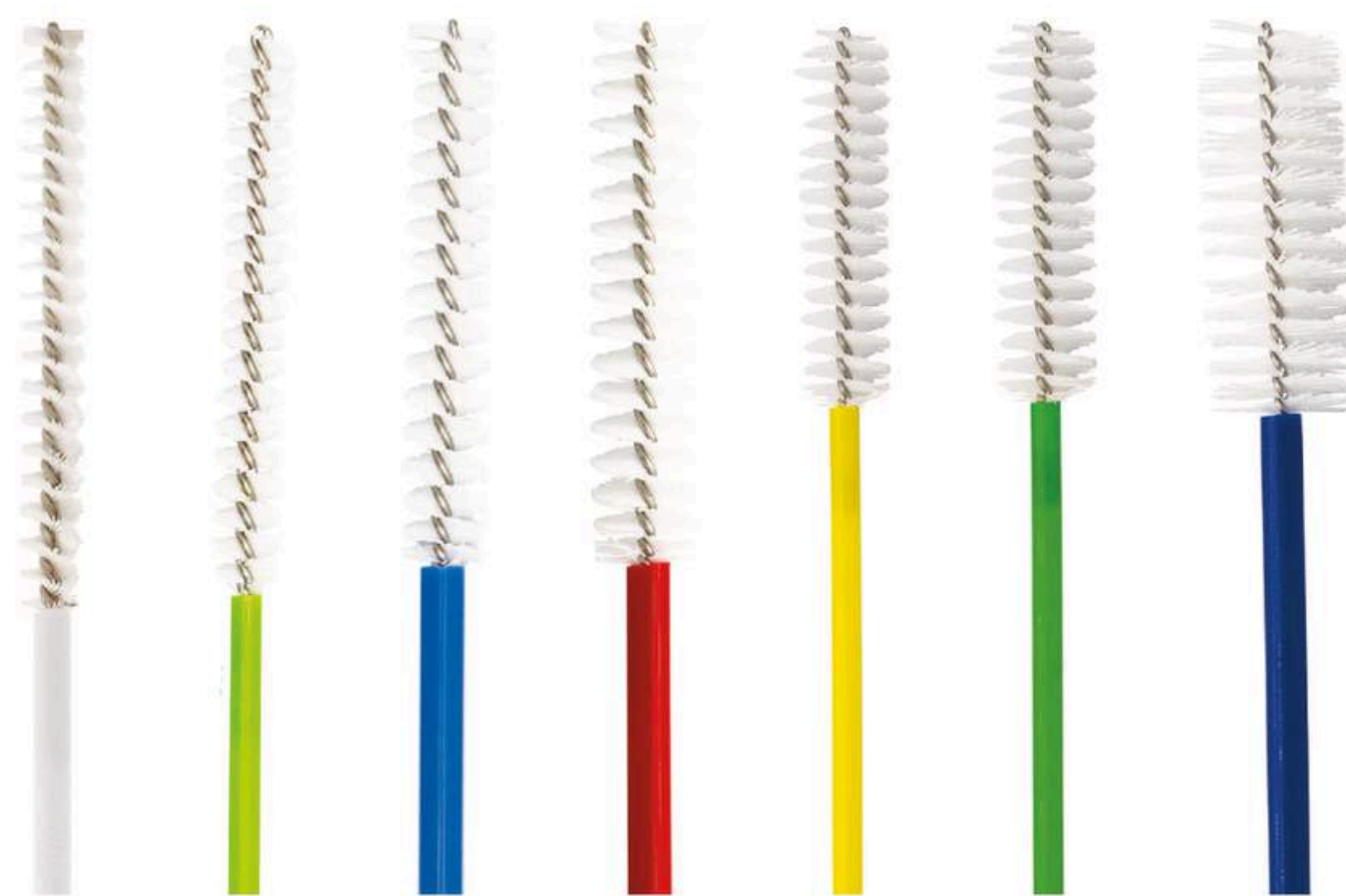

Code	Descript.	Pack	Notes
n/a	Plastic Handle Cleaning Brush - Various Sizes - Single & Double	3/pk & 50pk	Contact Trinity Med for more info.

Valve Cleaning Brushes



Scan for full brochure

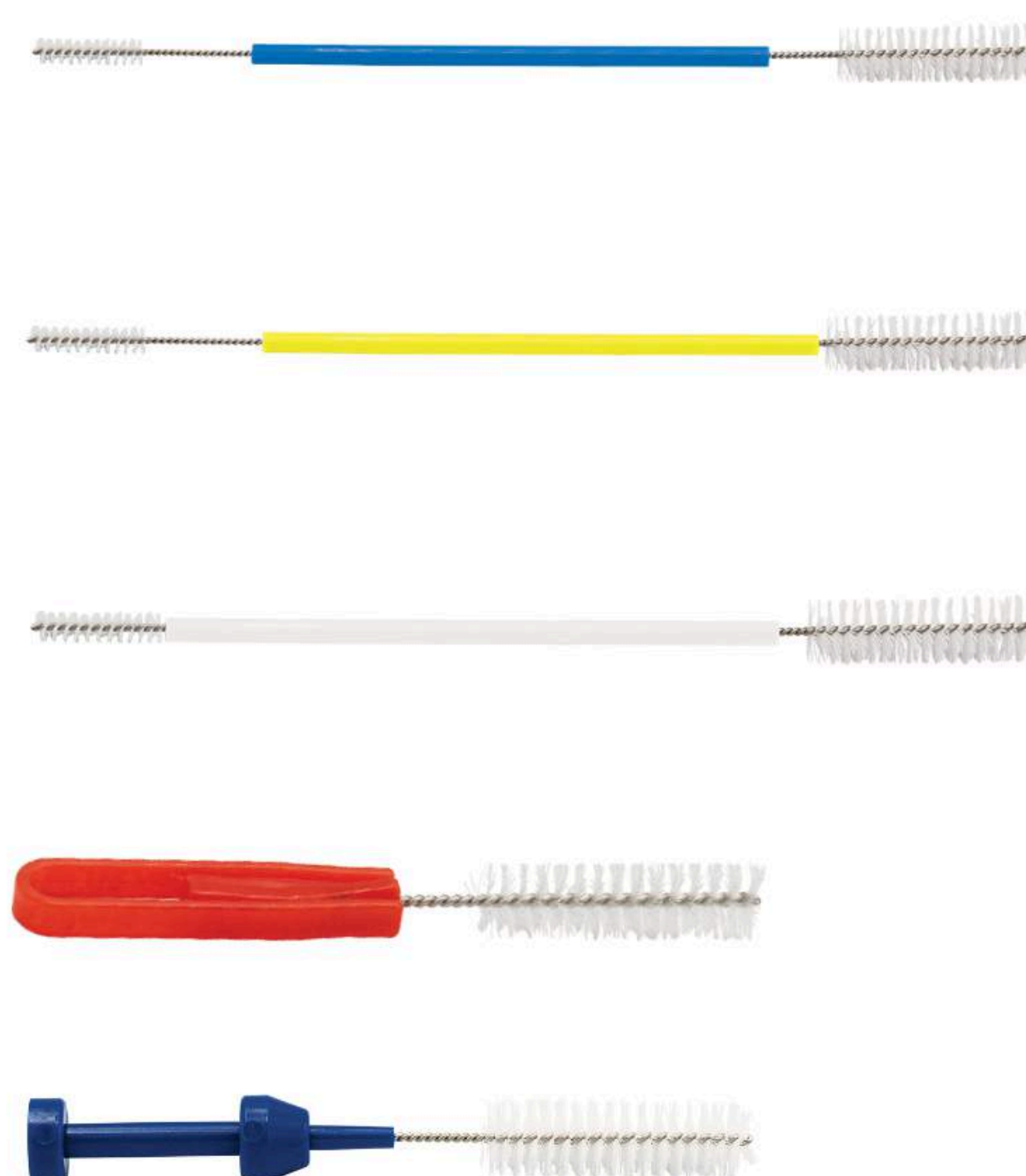

Code	Descript.	Pack	Notes
Scan or click on QR code for full brochure	Valve Cleaning Brush - Various Sizes	3/pk	Contact Trinity Med for more info.

Bottle & Drain Brushes



Code	Descript.	Pack	Notes
50-10295	Reusable Jar / Bottle Brush	3/pk	Autoclavable
50-10224	Sterilizer Drain Cleaning Brush	3/pk	Autoclavable

Channel Brushes - Individual & Sets

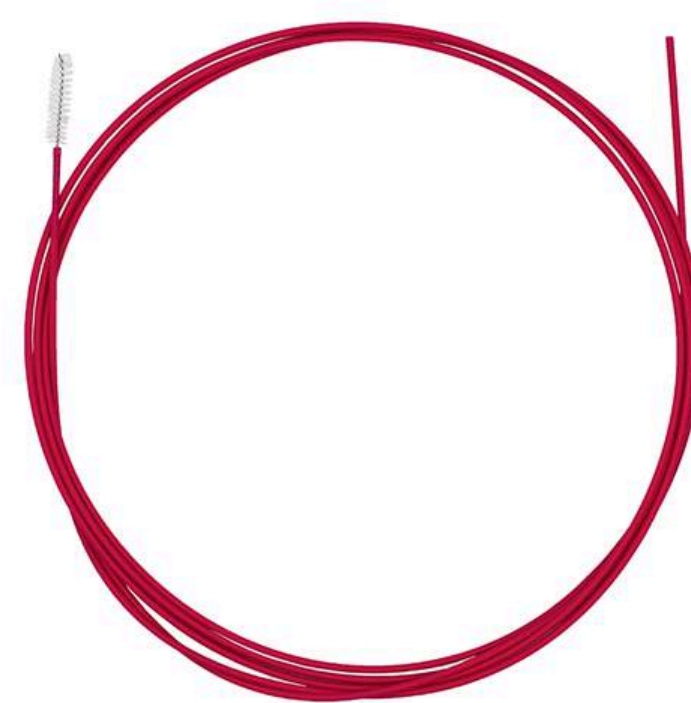

Scan for full brochure

Code	Descript.	Pack	Notes
Scan or click on QR code for full brochure	Channel Cleaning Brushes - Various Sizes	various	Contact Trinity Med for more info.

Double Ended Brushes



Code	Descript.	Pack	Notes
28-69394 / 28-69394-50	Double Ended Brush - Nylon	3/pk or 50/pk	n/a
29-69394 / 29-69394-50	Double Ended Brush - Steel	3/pk or 50/pk	n/a

Pipe Cleaners



Code	Descript.	Pack	Notes
SOFTEM004	SoftClean Pipe-Cleaner 9mm x 30cm	Pk/50	More sizes available
SOFTEM033	SoftClean Pipe-Cleaner 3mm x 30cm	Pk/50	More sizes available



Padlock Security Tags - Complete Range



Scan for full brochure

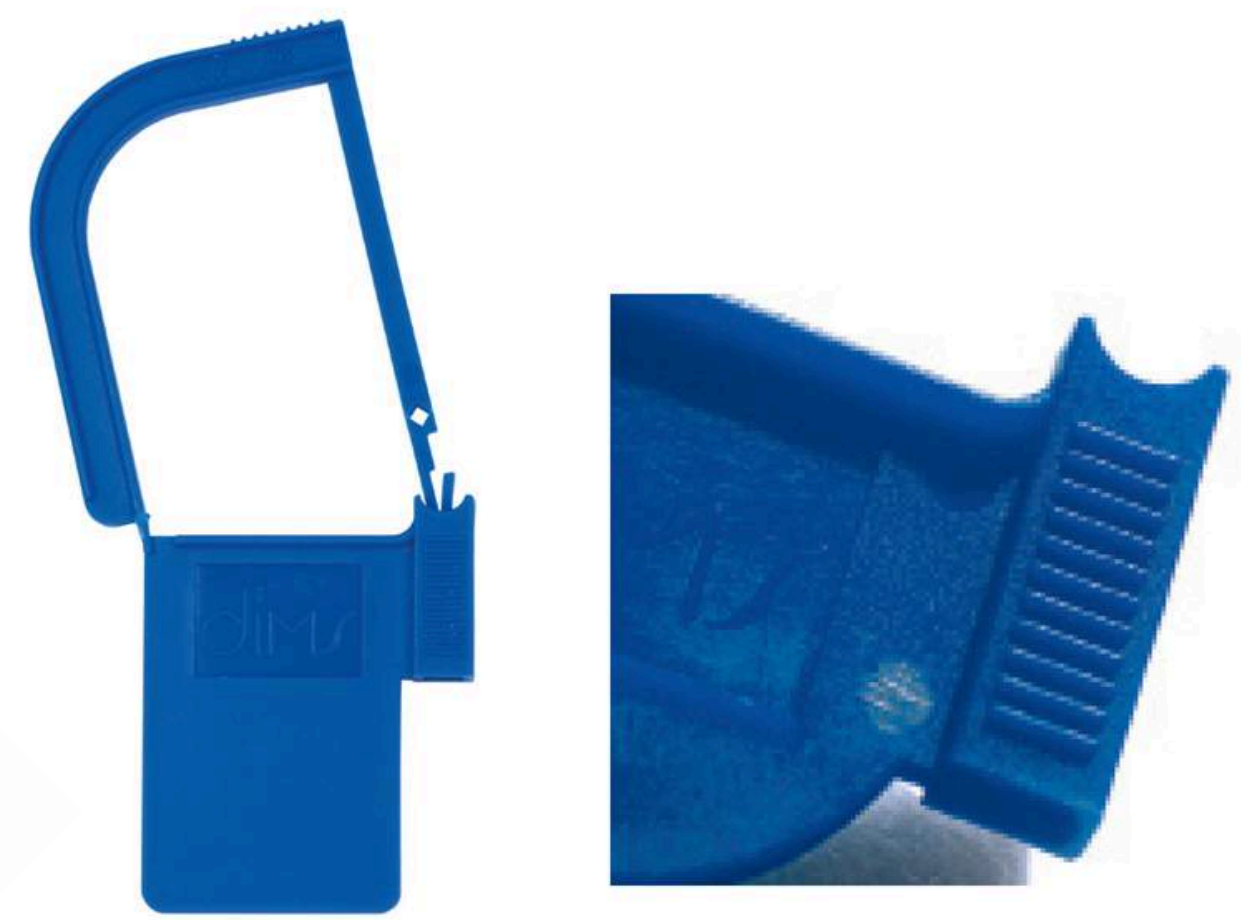
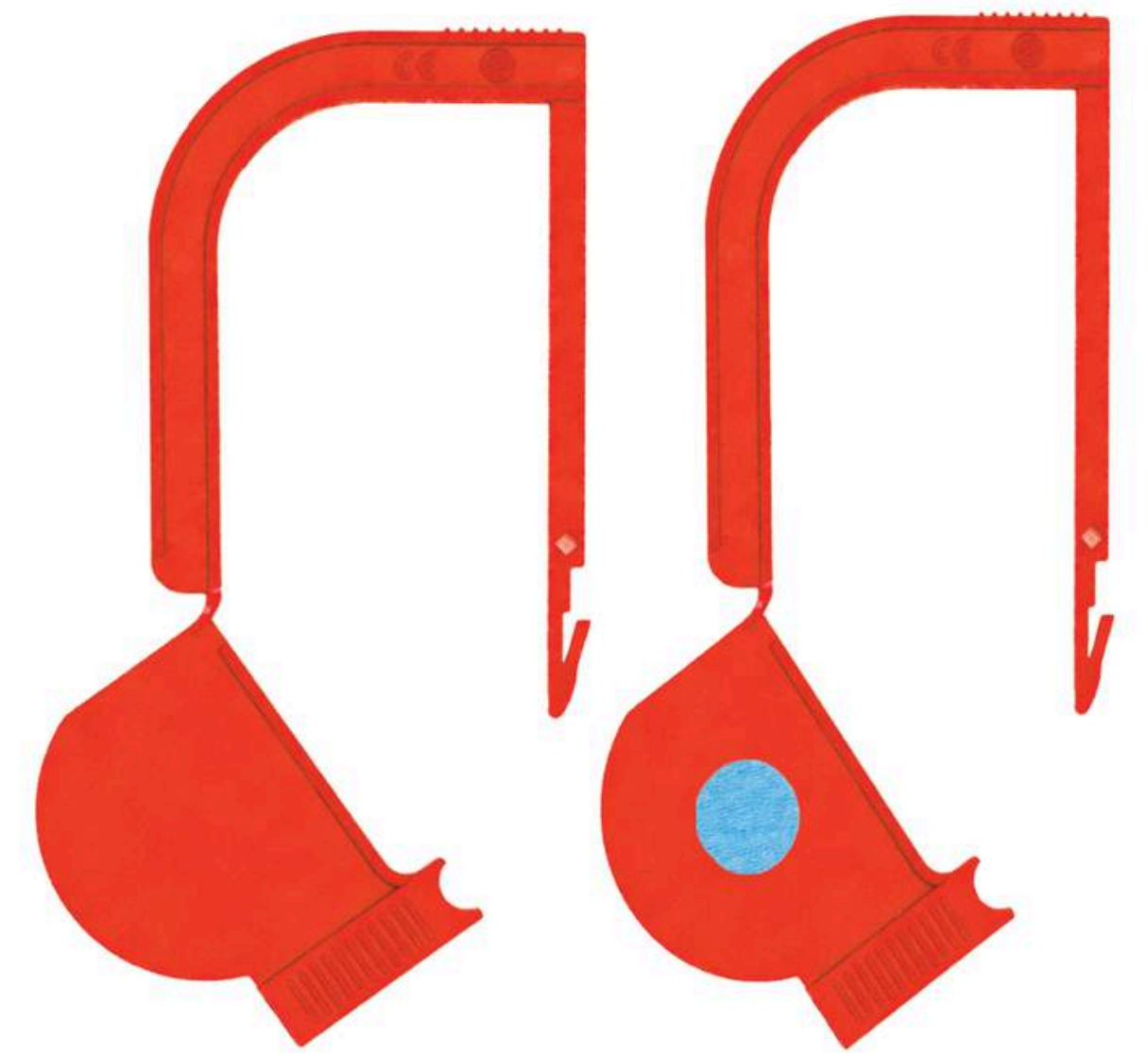

Code	Descript.	Pack	Notes
Various	Full Range Available	-	Contact Trinity Med for more info.

Protective Corner Pockets

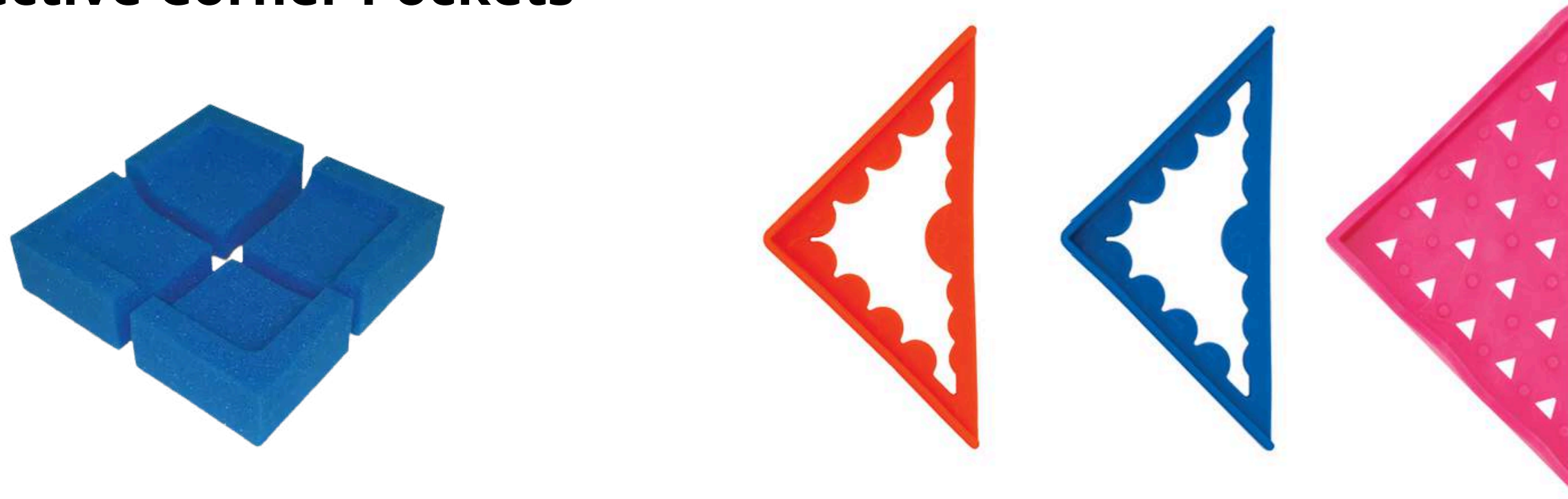

Scan for full brochure

Code	Descript.	Pack	Notes
Various	Variety of disposable and reusable protective corner pockets	n/a	Foam and Silicon variations available.

Instrument Tip Protectors - Double



Scan for full brochure

Code	Descript.	Pack	Notes
Various	Double Tip Protectors	50/pk	Contact Trinity Medical for information

Instrument Tip Protectors - Single



Code	Descript.	Pack	Notes
Various	Single Tip Protectors	100/pk	Contact Trinity Med for more info.

Misc Instrument Tip Protectors



Code	Descript.	Pack	Notes
Various	Miscellaneous Tip Protectors	-	Contact Trinity Med for more info.



Scrub Pad for Instruments



Code	Descript.	Pack	Notes
60-46003	Scrub Pad for Instruments	3/pk & 50pk	n/a

Silicon Pin Mat



Code	Descript.	Pack	Notes
13-2001	Silicon Pin Mat	1pk & 5pk	n/a



Anti-Fog Solution



Code	Descript.	Pack	Notes
G.O.L.F.F.	Anti-Fog Solution & Adhesive Sponge set	20/bx	Contact Trinity Med for more info.

Clamp Jaw Covers



Code	Descript.	Pack	Notes
Various	Clamp Jam Covers	Various	Sterile & Non Sterile available. Contact Trinity Medical for more info.

Pin Guards



Code	Descript.	Pack	Notes
Various	Pin Guards for K Wires	n/a	Contact Trinity Med for more info.

Anti-Fatigue Mats



Code	Descript.	Pack	Notes
800-2401	Anti-Fatigue Mat	1 / Box	18" X 24" / 46 cm x 61 cm
800-2405	Anti-Fatigue Mat	5 / Box	18" X 24" / 46 cm x 61 cm
800-3201	Anti-Fatigue Mat	1 / Box	20" X 32" / 51 cm x 81 cm
800-3203	Anti-Fatigue Mat	3 / Box	20" X 32" / 51 cm x 81 cm
800-4801	Anti-Fatigue Mat	1 / Box	20" X 48" / 51 cm x 122 cm
800-4802	Anti-Fatigue Mat	2 / Box	20" X 48" / 51 cm x 122 cm
800-7201	Anti-Fatigue Mat	1 / Box	30" X 72" / 76 cm x 183 cm

Cautery Tip Cleaner



Code	Descript.	Pack	Notes
60-10000	Cautery Tip Cleaner Non-Sterile	2,200 /Bx	4.5 cm x 4.5 cm



Instrument Organisation & Protection - Foam



Foam pouches prevent costly damage to instrument tips caused by shifting during handling and transport. Pouches neither retain nor absorb moisture, are 100% porous allowing for full penetration of sterilant gases, and validated for use in steam and EtO sterilisers.

Code	Descript.	Pack	Notes
FP-1001	FOAM POUCH 3.75 X 10.06	CS-50	MOQs apply
FP-1002	FOAM TIP PROTECTOR	CS-50	MOQs apply
FP-1003	FOAM PINHOLE HOLDER	CS-50	MOQs apply
FP-1004	FOAM CORNER PROTECTORS (SET OF 4)	CS-288	MOQs apply
FP-1005	12 INSTRUMENT FOAM PROTECTOR	CS-50	MOQs apply
FP-4600	FOAM PROTECTION PRODUCTS - ROLL 12W X 108L	CS-3	MOQs apply
FP-4800	FOAM PROTECTION PRODUCTS - PRECUT SHEETS 12W X 10L	CS-50	MOQs apply
FP-4850	FOAM PROTECTION PRODUCTS - PRECUT SHEETS 12W X 16L	CS-25	MOQs apply
FP-4880	FOAM PROTECTION PRODUCTS - PRECUT SHEETS 12W X 20L	CS-25	MOQs apply
FP-5200	FOAM PROTECTION PRODUCTS - MULTI-POUCH WITH BELTS - 11W X 15L	CS-10	MOQs apply
FP-5500	FOAM PROTECTION PRODUCTS - UNIVERSAL MULTI-POUCH - 13W X 17L	CS-10	MOQs apply
FP-6200	FOAM PROTECTION PRODUCTS - ENDOSCOPIC POUCH - 2W X 20L	CS-50	MOQs apply
FP-6210	FOAM PROTECTION PRODUCTS - LARGE POUCH - 4W X 7L	CS-50	MOQs apply
FP-6250	FOAM PROTECTION PRODUCTS - SMALL SINGLE POUCH - 2.1W X 7.5L	CS-50	MOQs apply
FP-6270	CAMERA/FIBER-OPTIC CABLE 9.5W X 10L	CS-10	MOQs apply



Magnifying Lamp



Code	Descript.	Pack	Notes
D25110-UK	5 LED Magnifier Lamp	each	Clamp fixing or table stand available.

LED 4X MAGNIFIER



Code	Descript.	Pack	Notes
MAG-002	LED 4x Magnifier	each	n/a

Paper Style Tip Protector



Code	Descript.	Pack	Notes
HE1-0006-W	Paper Style Tip Protector	100/bx	168 x 90mm

Instrument Stringers

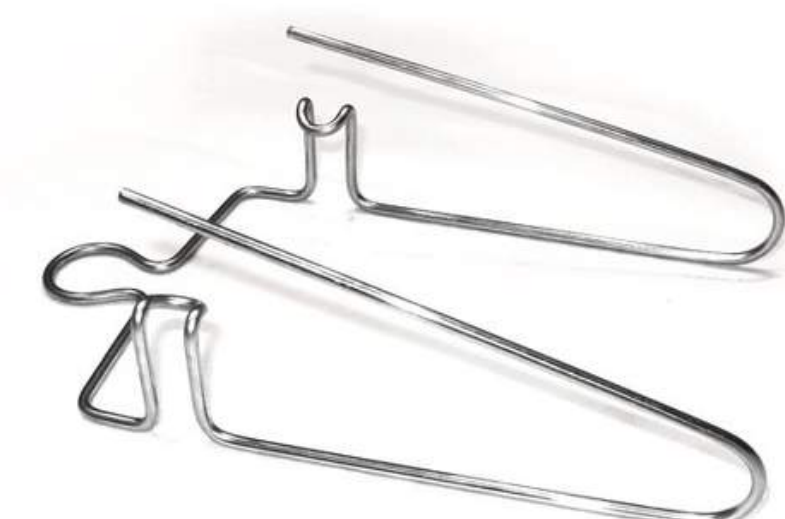

Code	Descript.	Pack	Notes
Various	Multiple Options Available	-	Contact Trinity Medical for more info.

Autoclave Cleaning Brush Kit



Code	Descript.	Pack	Notes
50-CLAVESUP	Autoclave SUPERIOR Brush Cleaning Kit	each	n/a

Spray Gun - Air & Water



Code	Descript.	Pack	Notes
Various	Air / Water Spray Gun - Multiple options available	each	Contact Trinity Medical for more info.

Identification Labels & Label Tags



Code	Descript.	Pack	Notes
Various	Various colours available, including variants with text such as 'Bio-hazard' and 'Repair'.	-	Contact Trinity Medical for more info.

Tape-B-Gone™ Tape Remover



Code	Descript.	Pack	Notes
T-32RMV	Tape-Be-Gone Tape Remover	4 x 237ml	n/a



Electrosurgical Insulation Defect Detector



Electrosurgical insulation defect detector is a compact, hand held, battery operated unit that is used to detect and locate defects such as pinholes, cracks and bare spots in protective coatings applied over conductive instrument's surfaces.

Code	Descript.	Pack	Notes
n/a	Insulation Tester	each	Contact Trinity Medical for more info.

Flexible Inspection Scope

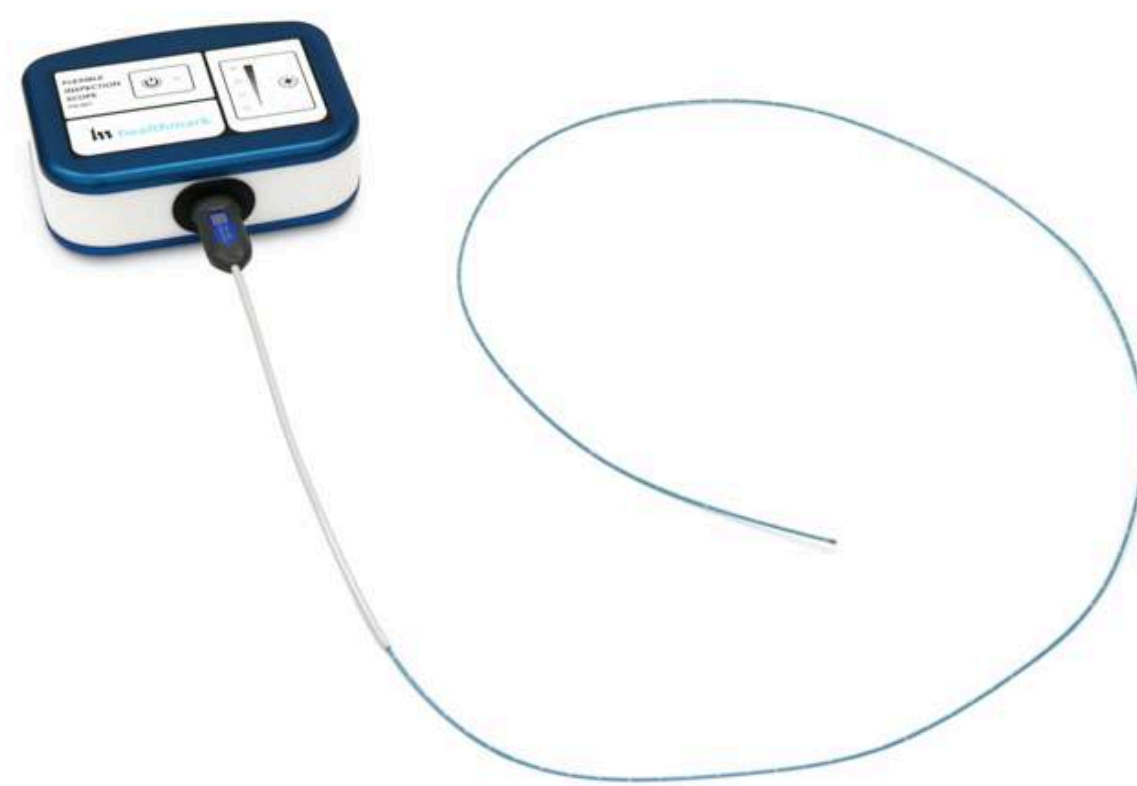

Designed to inspect internal channels of 1.3mm in diameter or larger, the FIS-006SK is the ideal tool to visually inspect potentially soiled or damaged items. The flexible inspection scope is 1.18mm in diameter, equipped with a distal tip composed of a light source and camera lens at the end of a 110cm black graduated shaft that connects to the included control box, which allows for image capture and recording. The FIS provides light, vision, magnification and the ability to document in hard-to-see crevices and lumens not visible to the unaided eye.

Code	Descript.	Pack	Notes
n/a	Flexible Inspection Scope	each	Contact Trinity Medical for more info.

MAGIC TOUCH MAGNIFIER



Code	Descript.	Pack	Notes
RNDMAG-1	Magic Touch Magnifier	each	9.53 x 4.57h

Residual Protein Testing



Code	Descript.	Pack	Notes
PS1700	25 Tests with short swabs.	each	High sensitivity, with control test.
PS1710	Endoscopy 25 Tests with long swabs 1.9mm	each	High sensitivity, with control test.
PS1720	Endoscopy 25 Tests with long swabs 2.8mm	each	High sensitivity, with control test.
PS1730	Endoscopy 25 Tests with long swabs 3.7mm	each	High sensitivity, with control test.

Cleaning Efficacy Indicators - CEIs



Code	Descript.	Pack	Notes
PS1600	Cleaning Efficacy Indicators	50/bx	Available for lumens also.

Foil Test for Ultrasonic Baths & Irrigators



Code	Descript.	Pack	Notes
PS2220	Ultrasonic Foil Test	50/bx	n/a



Terragene Ultrasonic Cavitation Test

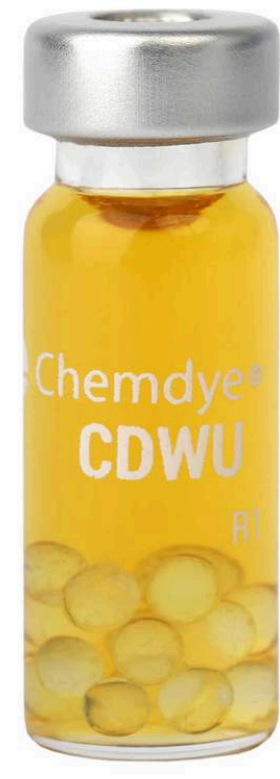

Code	Descript.	Pack	Notes
CDWU	Ultrasonic Cavitation Test	30/BX	n/a

Terragene SPLAT - Washing Indicator



Scan for to watch video



Code	Descript.	Pack	Notes
CDWA4 - High	Splat - Cleaning Efficacy Indicators	200/pk	Compatible with Trazanto
CDWA3 - MED	Splat - Cleaning Efficacy Indicators	200/PK	Compatible with Trazanto

Terragene Bowie & Dick Test Pack



Scan for to watch video



Code	Descript.	Pack	Notes
BD125X-2	Bowie & Dick Test Pack	20/bx	High Contrast Colour Change. Compatible with Trazanto.

Type 6 Indicator



Code	Descript.	Pack	Notes
PS1110	Class 6 Emulating Indicators	250/bx	For steam sterilisation

Push Dye Test for Heat Seal Reels & Pouches



Code	Descript.	Pack	Notes
44100	For Paper Packing	30/bx	n/a
44110	For Tyvek Packing	30/bx	n/a

Seal Sure



Code	Descript.	Pack	Notes
PS2100	Routine monitor For Sealers	250/pk	n/a

Terragene High Sensitivity Pen for Quantifiable Protein Detection

The HSE recommends the use of technologies to allow for the quantification of proteins.



Code	Descript.	Pack	Notes
PRO1MICRO	Swab & Incubate for Quantifiable Protein Detection	100/bx	Use with MiniPro Incubator

Terragene Trazanto Analyser



AUTOMATIC SYSTEM FOR QUALITY CONTROL AND TRACEABILITY OF CLEANING, DISINFECTION AND STERILIZATION PROCESSES

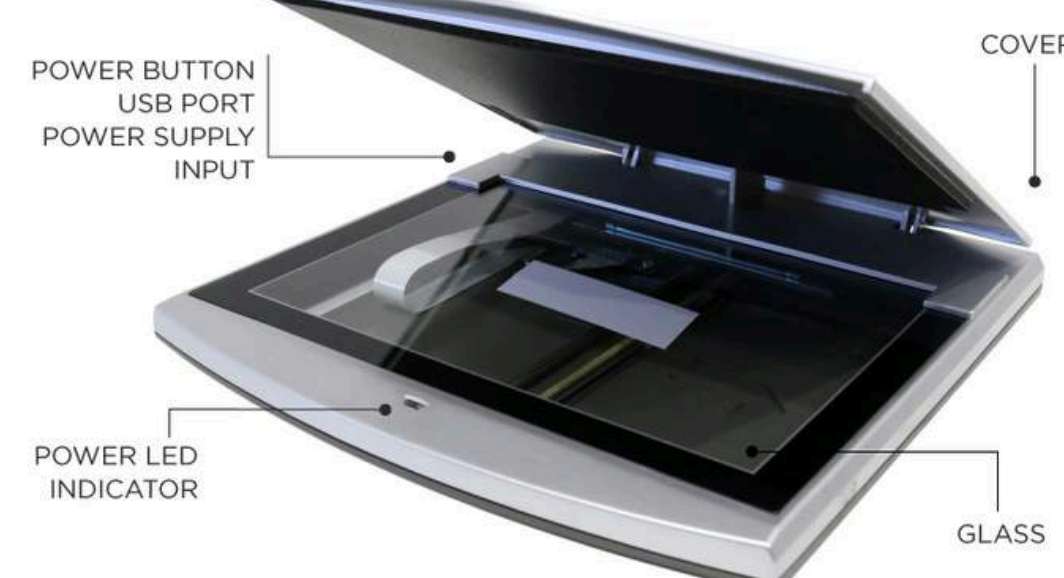

Code	Descript.	Pack	Notes
TRAZANTO	Analyser for Various Indicators	each	See video for more info

Biological Indicator for Steam - 20 min



Code	Descript.	Pack	Notes
BT224	20 min Biological Indicator for Steam	50/bx	Geobacillus stearothermophilus

Biological Indicator for Hydrogen Peroxide - 2 Hour



Code	Descript.	Pack	Notes
BT95	2h Biological Indicator for Hydrogen Peroxide	50/BX	Geobacillus stearothermophilus

MiniBio Auto-Reader for Rapid Read-out of Biological Indicators



Code	Descript.	Pack	Notes
MINIBIO	Incubator for Biological Indicators	each	n/a

Lumenia Six Flow Cleaning Challenge - For AERs



Scan for to watch video

Code	Descript.	Pack	Notes
LSF1	6 Channel AER Challenge Device	each	Compatible with Trazanto



EnziMed Pre-Cleaner



Code	Descript.	Pack	Notes
OL20304	Multi-enzymatic foam spray for surgical instruments	6/bx	n/a

EnziMed 4 - Standard Enzymatic Detergent for Manual Cleaning



Code	Descript.	Pack	Notes
OL20506	Low Foaming Enzymatic Detergent 5ltr.	4/bx	For manual and ultrasonic cleaning applications

EnziMed 5 - Enzymatic Detergent for Instrument Washer Disinfectors



Code	Descript.	Pack	Notes
OL20206	EnziMed Instrument Washer 5ltr.	4/bx	Non foaming for automated washer disinfectors.

OneLife - Detect 2



Code	Descript.	Pack	Notes
OL22329	Detect 2 Reveals Organic Contamination Real-time 950ml	6/bx	Contact Trinity Med for more info

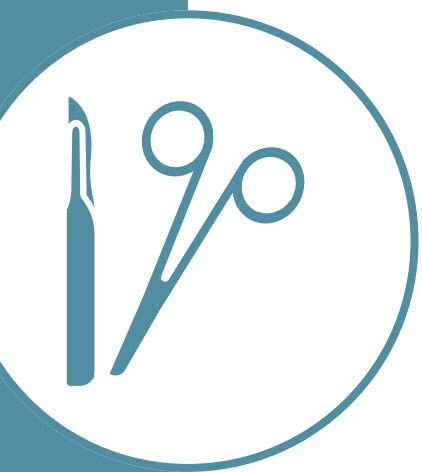

Specialist Baskets for Rigid Scopes & Robotic Surgery (DaVinic)

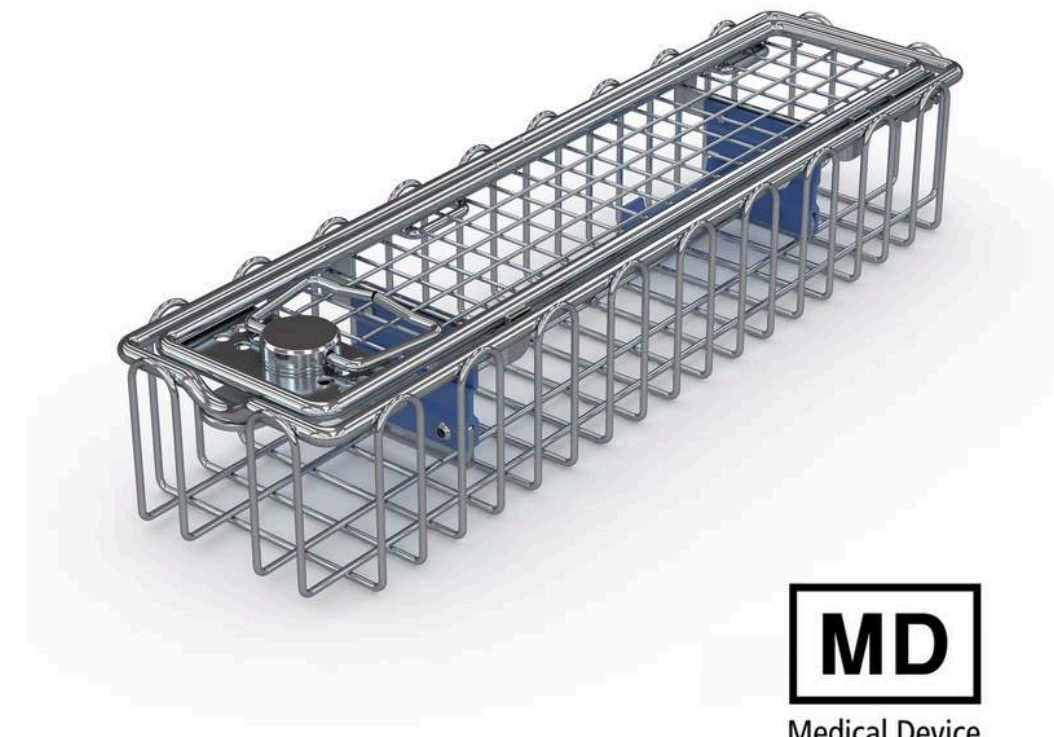

MD
Medical Device

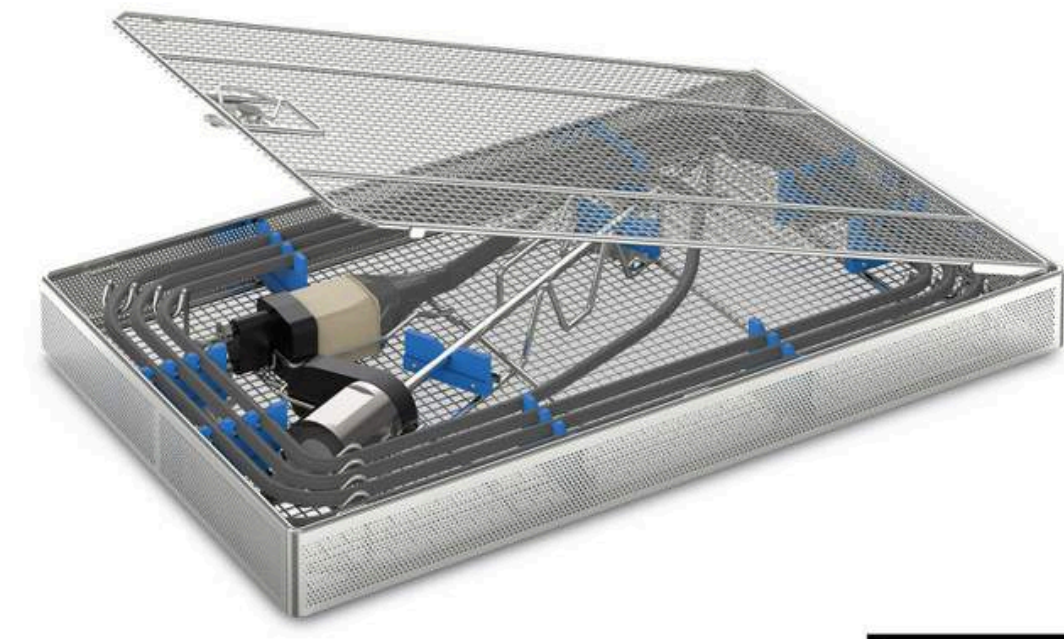

MD
Medical Device

Code	Descript.	Pack	Notes
n/a	Various models & sizes available	each	Contact Trinity Med for more info.

Instrument Trays DIN

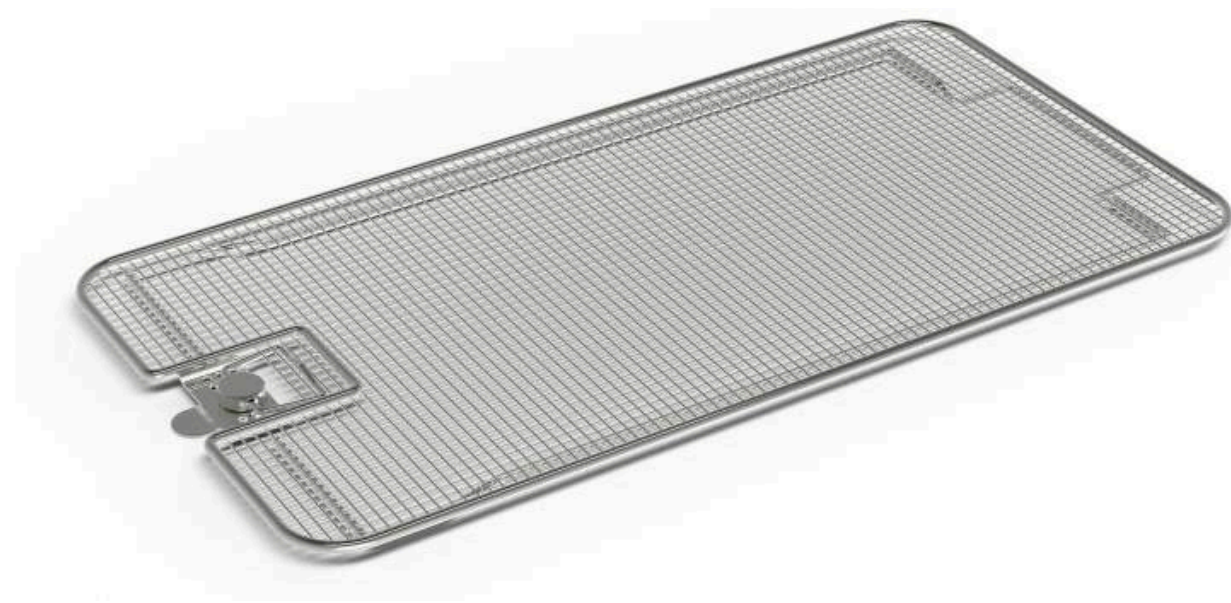

Code	Descript.	Pack	Notes
7500046	1/2 DIN 240x250x70mm	each	n/a
7500048	Full DIN 480x250x70mm	each	n/a
7500049	Full DIN Deep 480x250x100mm	each	n/a
7500911	Lid for Full DIN	each	n/a
7500912	Lid for 1/2 DIN	each	n/a

Fine Mesh Baskets

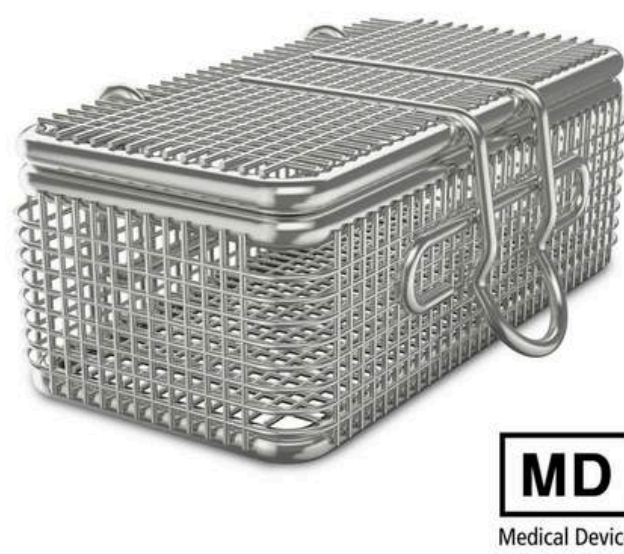

MD
Medical Device



MD
Medical Device



MD
Medical Device



Download the complete Hupfer brochure

Code	Descript.	Pack	Notes
7501282	Fine Mesh Basket with Lid & Clasp	each	80 x 40 x 30mm
7501220	Fine Mesh Basket with Lid & Clasp	each	80 x 49 x 42mm
7501132	Fine Mesh Basket with Lid & Clasp	each	80 x 80 x 40mm
7501204	Fine Mesh Basket with Lid & Clasp	each	200 x 100 x 50mm
7501133	Fine Mesh Basket with Lid & Clasp	each	220 x 140 x 50mm
7501135	Fine Mesh Basket with Lid & Clasp	each	274 x 174 x 36mm
7501161	Fine Mesh Basket with Lid & Clasp	each	210 x 150 x 40mm
7501162	Fine Mesh Basket with Lid & Clasp	each	310 x 210 x 40mm



SMS Heavy Grade Wrap - Interleaved



Code	Descript.	Pack	Notes
T4007575	Blue / Green SMS Interleaved Wrap for Steam and VH2O2	126 sheets per box	75x75cm
T4009090	Blue / Green SMS Interleaved Wrap for Steam and VH2O2	100 sheets per box	90X90cm
T500100100	Blue / Green SMS Interleaved Wrap for Steam and VH2O2	100 sheets per box	100x100cm
T500120120	Blue / Green SMS Interleaved Wrap for Steam and VH2O2	76 sheets per box	120x120cm

Reels & Pouches



Code	Descript.	Pack	Notes
Various	Reels and Pouches	n/a	Contact Trinity Med for more info.

Tyvek Reels & Pouches



Code	Descript.	Pack	Notes
Various	Flat Reels and Pouches for low temperature sterilisation VH2O2	n/a	Contact Trinity Med for more info.

Gandus Rotary Heat Sealer - Pura



Code	Descript.	Pack	Notes
PURA	Validatable Medical Rotary Heat Sealer. Touch Screen.	each	Available with front support plate. Printer included.

Reel Holder with Cutting Blade



Code	Descript.	Pack	Notes
n/a	Stainless steel Reel Holder, fitted with a cutting blade.	each	Available in various widths.

Ultrasonic Baths



Code	Descript.	Pack	Notes
n/a	Various models & sizes available	each	Contact Trinity Med for more info.

Wrap Holder



Code	Descript.	Pack	Notes
7500371	Holder for Sterile Barrier Sheets	each	Available with lower retaining grid.

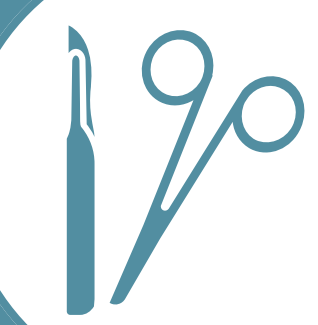

Hupfer Packing Tables

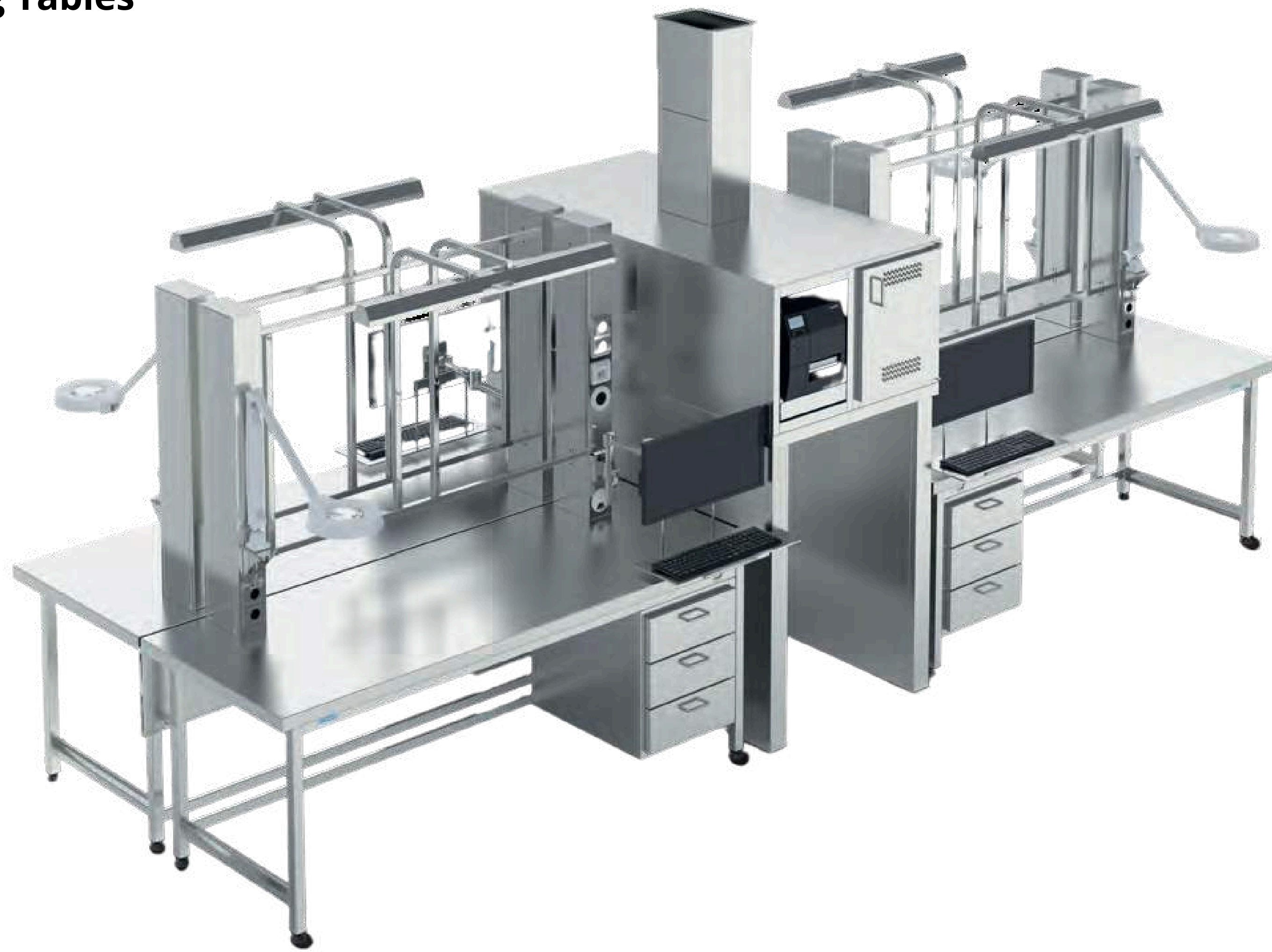

Code	Descript.	Pack	Notes
n/a	Customisable Height Adjustable Packing Stations	each	Contact Trinity Medical for more info.

Ensure Touch ATP Hygiene Monitoring



Code	Descript.	Pack	Notes
ETOUCH	Ensure Touch Cleaning Verification System	each	Contact Trinity Medical for more info.
US2020	Hygiena UltraSnap™ Surface Swap	pk/100	n/a
ASY0355	Endoswab 3mm	pk/100	n/a
ASY0469	Endoswab 2mm	pk/100	n/a
ASY0468	Endoswab 1mm	pk/100	n/a

Sychem Control Plus Wipes



Code	Descript.	Pack	Notes
SYC-SWC-W200	Control Plus Surface Wipes, Tub, Box of 6	Box of 6 Tubs	MOQ 3 Boxes

Sychem Control Plus - HLD Spray RTU



Code	Descript.	Pack	Notes
SYC-SWC-RTU	Control Plus Ready to Use Spray, High Level Disinfection	750mm x 12	-
SYC-020152-C-PLUS	Sychem Control Concentrate PLUS	5ltr x 2	-

Warwick SASco - Moulded Medical Plastics



Download the complete Warwick Sasco brochure

Code	Descript.	Pack	Notes
Various	Comprehensive range of medical plastics.	-	Contact Trinity Medical for more info.



Ultrasonic Irrigation Wash Station - Ultrasonic MED



Code	Descript.	Pack	Notes
n/a	Twin Bowl High Efficiency Ultrasonic Wash Station. Height adjustable, with in-built traceability software. Compatible with DaVinci Handpieces.	each	Contact Trinity Medical for more info.

Custom Stainless Steel Fabrication

Trinity Medical offers a design and custom fabrication service to help customers bring their ideas to fruition. Whether you require a bespoke wash-station, specialised instrument basket or customised transport system, our sales & engineering personnel will work with you to design a solution to fulfill your requirements. Contact us at info@trinitymed.ie.

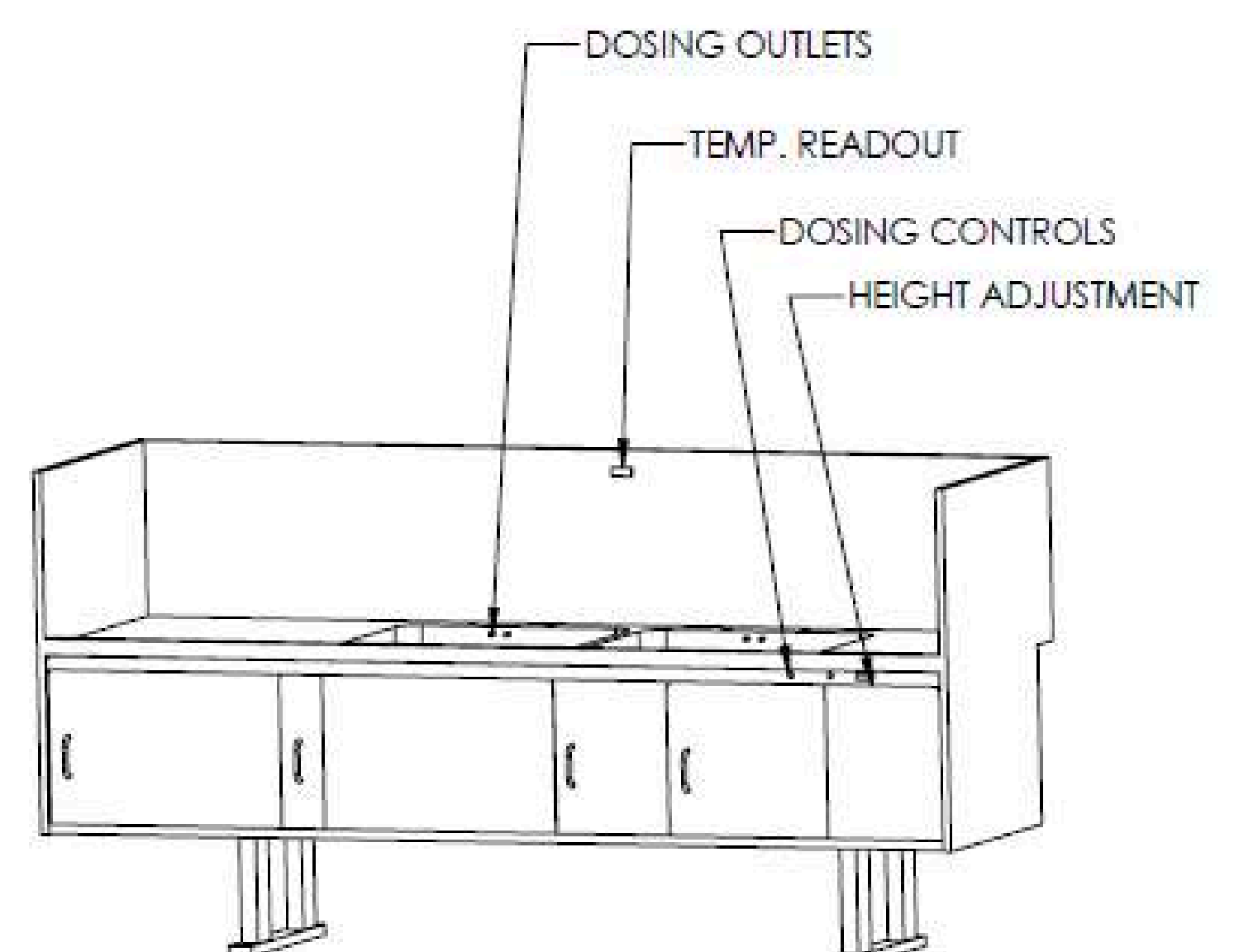
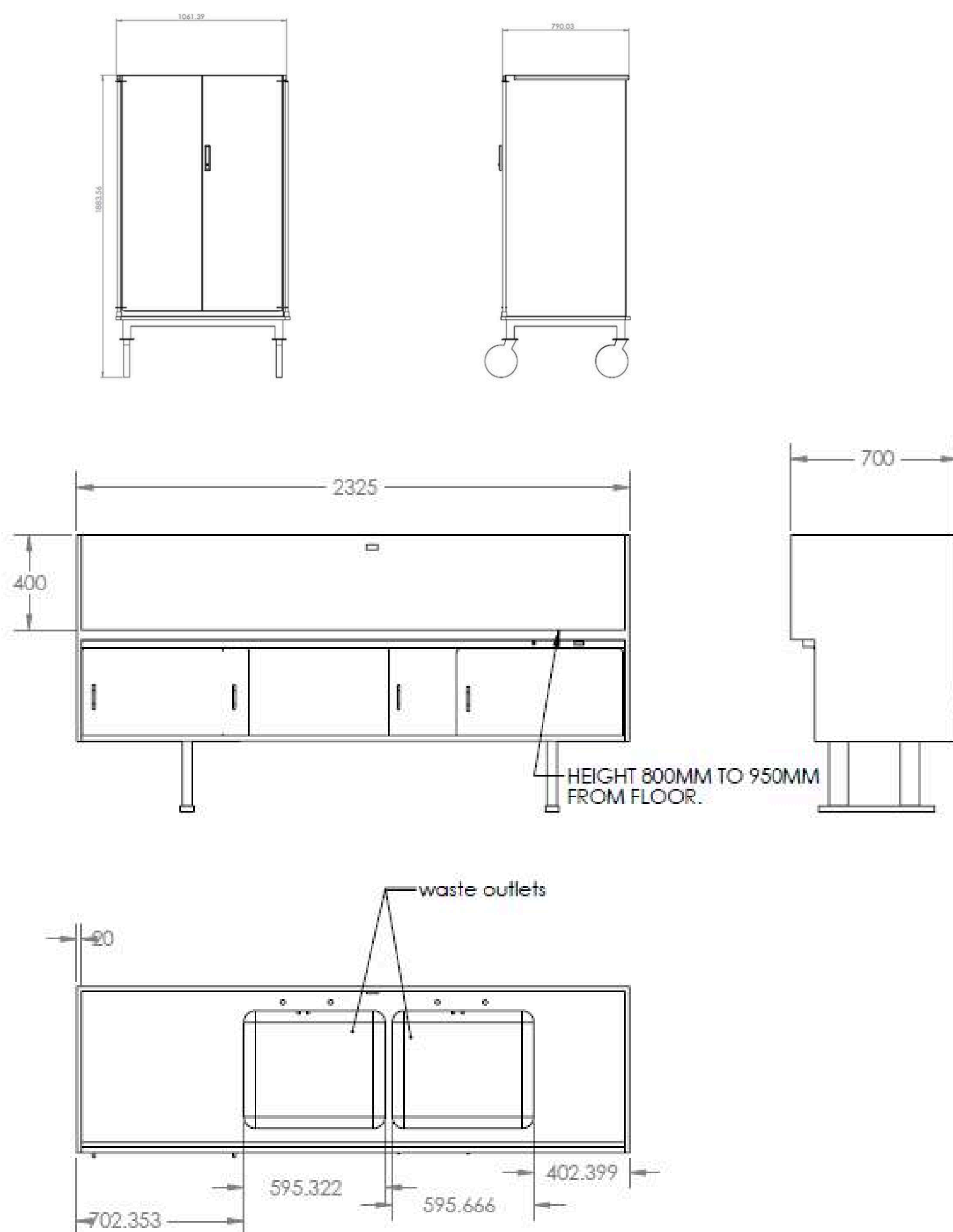

Distal Soak



Code	Descript.	Pack	Notes
50058	Distal Soak Open Cap	20	-
50065	Distal Soak Solid Cap	20	-
50069	Tube Holder	-	-

ChemEco Stainless Steel Cleaning Powder



Code	Descript.	Pack	Notes
CECO0030	4 x 1Kg Tub	1 x 4	-

Protective Transport Bags



Code	Descript.	Pack	Notes
PPU150250	Transport Bag 150X250mm	500	-
PPU200300	Transport Bag 200X300mm	500	-
PPU300550	Transport Bag 300x550mm	500	-
PPU400550	Transport Bag 400x550mm	250	-
PPU400750	Transport Bag 400x750mm	200	-
PPU600750	Transport Bag 600x750mm	200	-
PPU600900	Transport Bag 600x900mm	150	-





PRODUCTS FOR ENDOSCOPY

Ultrasonic Irrigation Wash Station - UltraZonic ENDO



Code	Descript.	Pack	Notes
ENDO	Twin Endoscope Manual Wash System for automated pre-cleaning of Endoscopes. Height-adjustable.	each	Contact Trinity Medical for more info.

Ultrasonic Irrigation Wash Station - UltraZonic ENDO Mini.



Code	Descript.	Pack	Notes
ENDO MINI	MINI is ENDO's little brother, especially designed for the pre-cleaning of ENT scopes, cystoscopes and bronchoscopes. Like our acclaimed ENDO device, the ENDO MINI also covers all the steps in the pre-cleaning semi-automatically.	each	Contact Trinity Medical for more info.

PAA Neutraliser



Code	Descript.	Pack	Notes
J94A	Neutralising Solution for Residual Peracetic Acid.	Box / 24	24 x 50ml bottles

ChemDAQ Steri-Trac 2+ Hazardous Vapour Monitoring Solutions



Code	Descript.	Pack	Notes
n/a	Steri-Trac 2 Fixed, continuous gas monitoring system for measuring occupational exposure to Ethylene Oxide (EtO), Hydrogen Peroxide (H ₂ O ₂) and Peracetic Acid (PAA).	each	n/a

Monmouth 'Circulaire' Self-Ventilating Chemical Storage Cabinet



Code	Descript.	Pack	Notes
n/a	Removes PAA vapours from ambient air. Available in a variety of sizes.	each	n/a

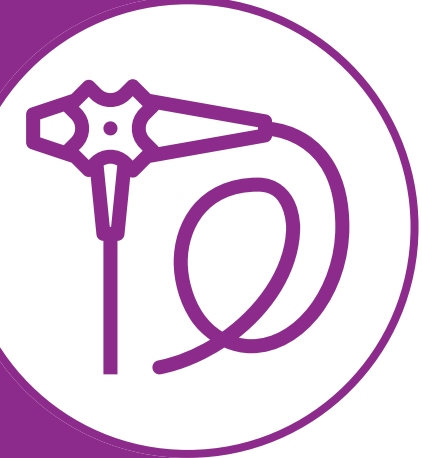

Endo Tray Liners - iM CleanEst



Clearly identify, store and transport **decontaminated** endoscopes



and **contaminated** endoscopes



Code	Descript.	Pack	Notes
125010	iM CleanEST Liners. Sterile. Red, Green and Clear tray liner.	Box/200	n/a

EndoTube - Disposable Tube Sets for Endoscopes

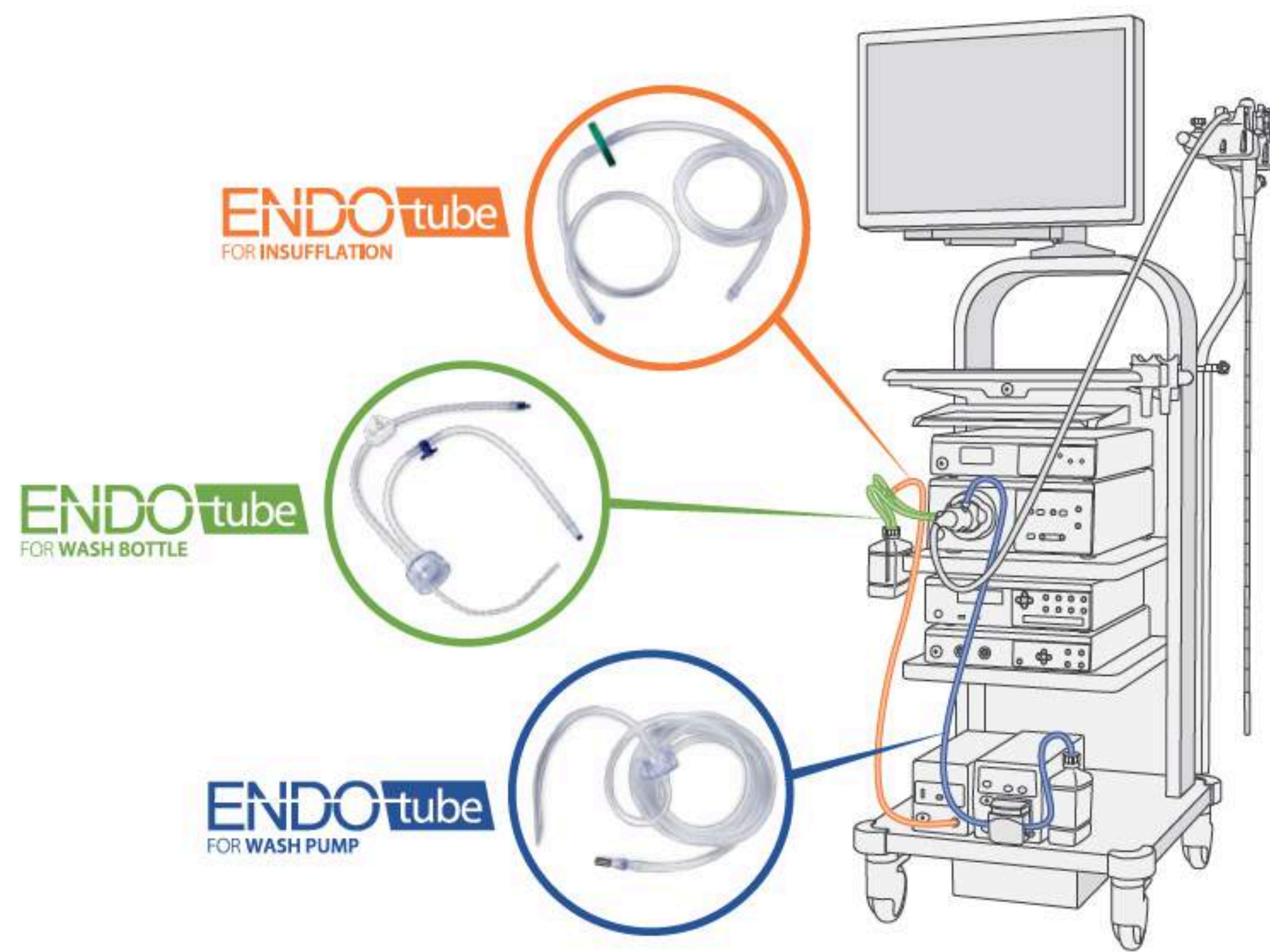

Code	Descript.	Pack	Notes
Various	Available for Air/Water, Insufflation and Irrigation. Compatible with Olympus, Fuji and Pentax.	pack/20	Contact Trinity Medical for more info.

Endoscopy Transport Trolley Systems



Code	Descript.	Pack	Notes
Various	Available in various formats, open, closed, multi-level. Customisable to meet your needs.	each	Contact Trinity Medical for more info.

Disposable Valve Sets



Code	Descript.	Pack	Notes
Various	Disposable Valve Sets for Olympus, Pentax & Fujifilm Endoscopes.	Box/200	n/a

Biopsy Valve with Irrigation Tube



Code	Descript.	Pack	Notes
830041	For Fujinon & Olympus	pack/400	Contact Trinity Medical for more info.

Biopsy Valve - Various



Code	Descript.	Pack	Notes
Various	Available for Olympus, Pentax & Fuji	each	Contact Trinity Medical for more info.

Bedside Cleaning Kit



Code	Descript.	Pack	Notes
110103 / 110105	300ml / 500ml with Flat Sponge	24	Contact Trinity Medical for more info.

Endoscope Flushing Device



Code	Descript.	Pack	Notes
SEB 1000 G1	Compact Device for Flushing of Endoscopes	each	-

Biopsy Valve with Irrigation Tube



Code	Descript.	Pack	Notes
830041	For Fujinon & Olympus	pack/400	Contact Trinity Medical for more info.

Biopsy Valve - Various



Code	Descript.	Pack	Notes
Various	Available for Olympus, Pentax & Fuji	each	Contact Trinity Medical for more info.

Bedside Cleaning Kit



Code	Descript.	Pack	Notes
110103 / 110105	300ml / 500ml with Flat Sponge	24	Contact Trinity Medical for more info.



TRINITY
MEDICAL

PATIENT CENTRIC TECHNOLOGIES

www.trinitymed.ie